

PIANO DI CASA MATERIALMENTE DIVISA HAUSTEILUNGSPLAN EINES MATERIELL GETEILTEN GEBÄUDES

P.ED. 2026 - P.T./II - SCALA 1:200
B.P. 2026 - Ezl./II - MASSTAB 1:200
SI ATTESTA CONFORME ALLO STATO REALE IN DATA 28/08/2019
DIE ÜBEREINSTIMMUNG MIT DER WIRKLICHKEIT ZUM 28/08/2019 WIRD BESTÄTIGT

STATO FINALE ENDSTAND

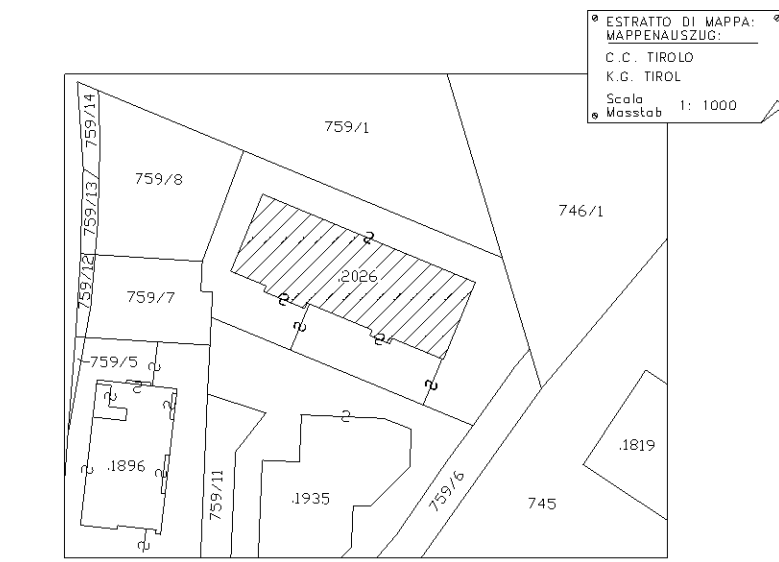

* ESTRATTO DI MAPPA:
MAPPENAUZUG
C.C. TIROLO
K.G. TIROL
Scala
Masstab 1:1000

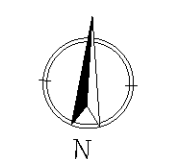

ESTRATTO MAPPA - MAPPENAUZUG 1:1000

ESTRATTO DI MAPPA CONFORME ALLE RISULTANZE DELLA MAPPA DI CONSERVAZIONE ALLA DATA DEL 28/08/2019
DIE ÜBEREINSTIMMUNG DES MAPPENAUZUGS MIT DER KATASERMAPPE ZUM 28/08/2019 WIRD BESTÄTIGT

PIANO INTERRATO UNTERGESCHOSS

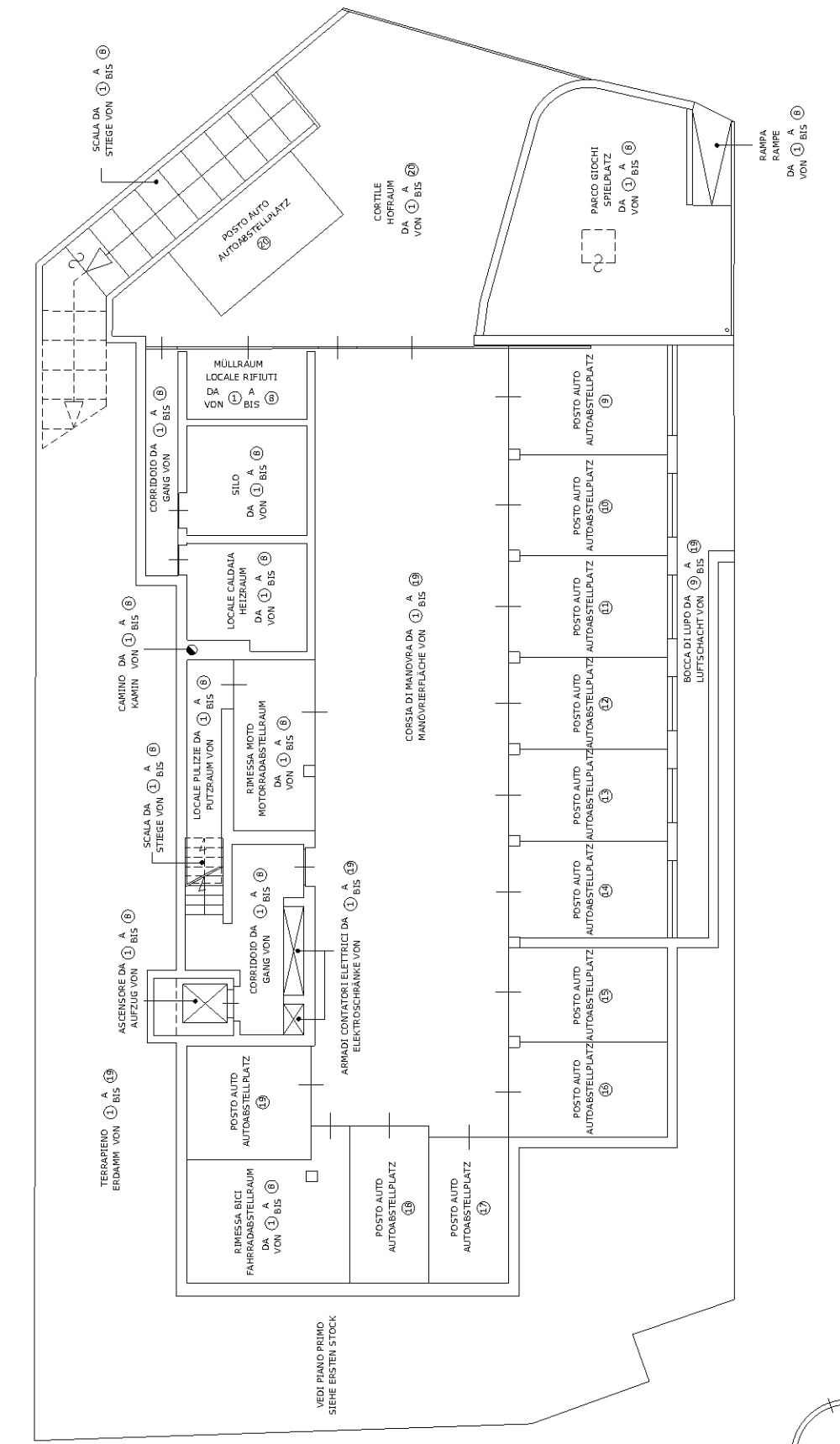

SCALA-MASSTAB 1:200

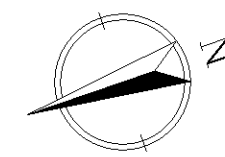

PIANO TERRA ERDGESCHOSS

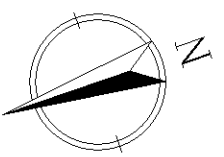
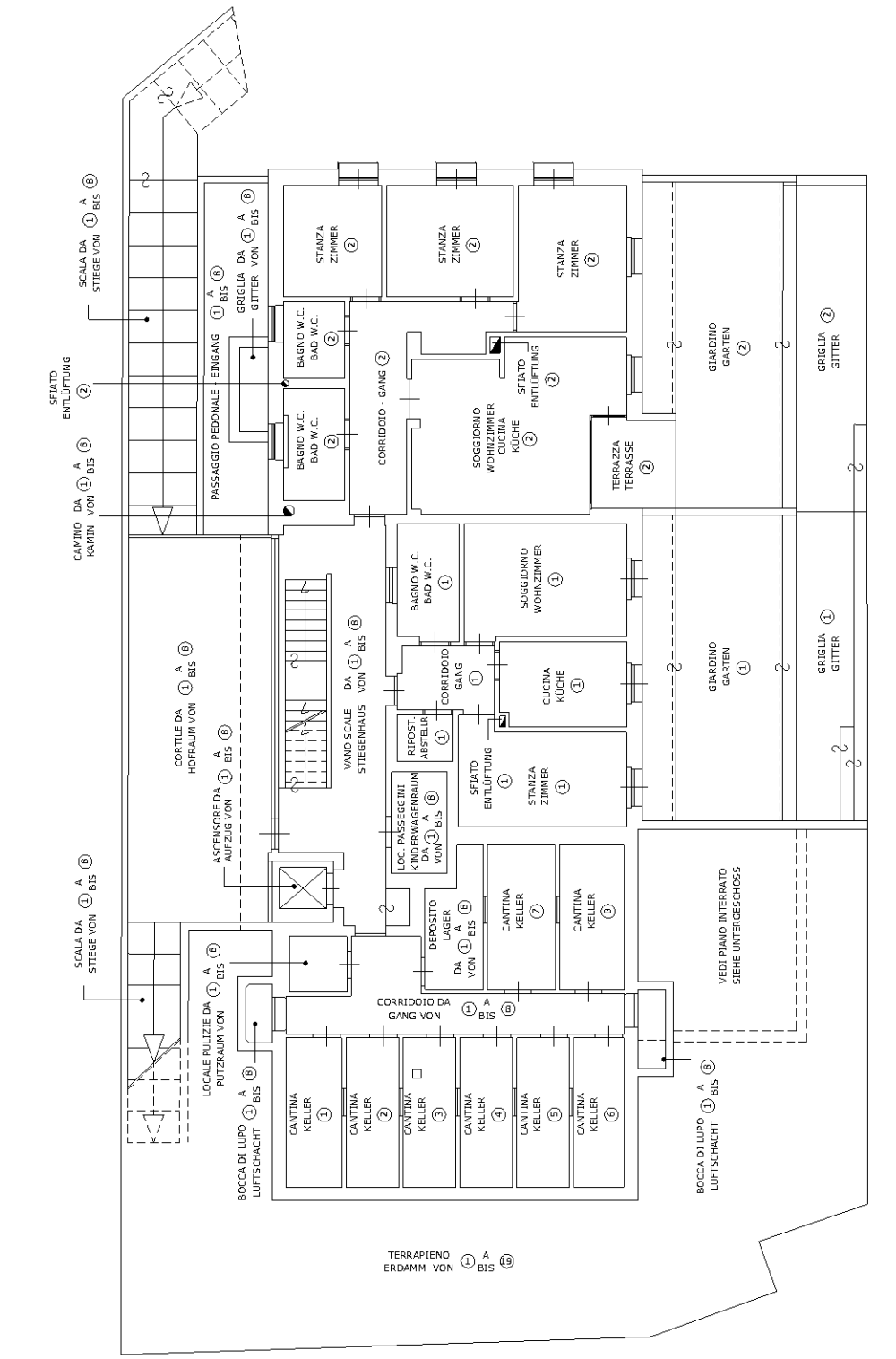

PIANO PRIMO ERSTER STOCK

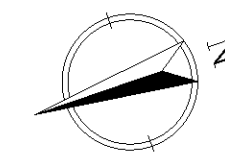
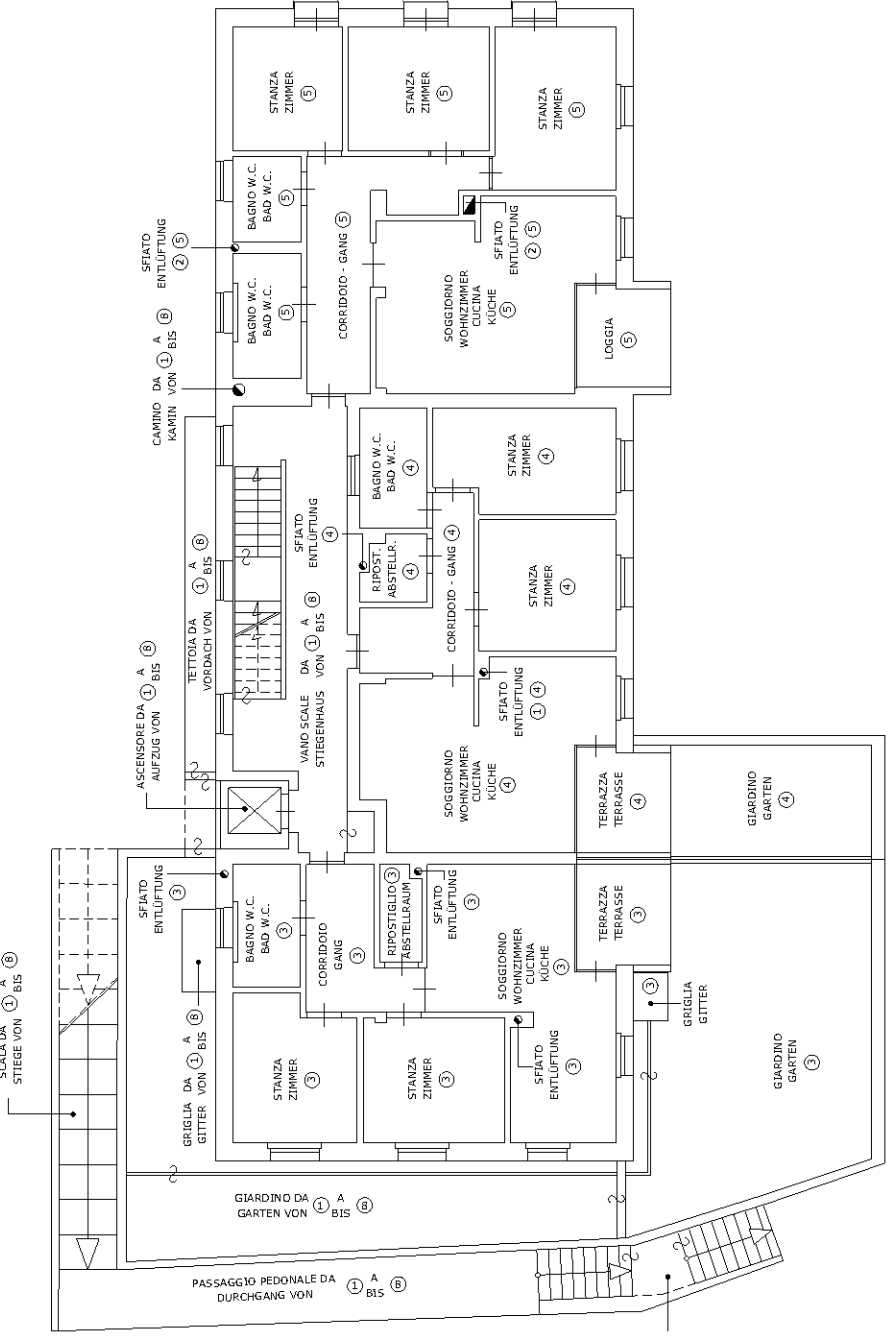

PIANO SECONDO ZWEITER STOCK

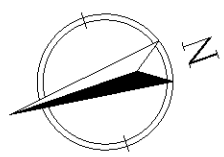
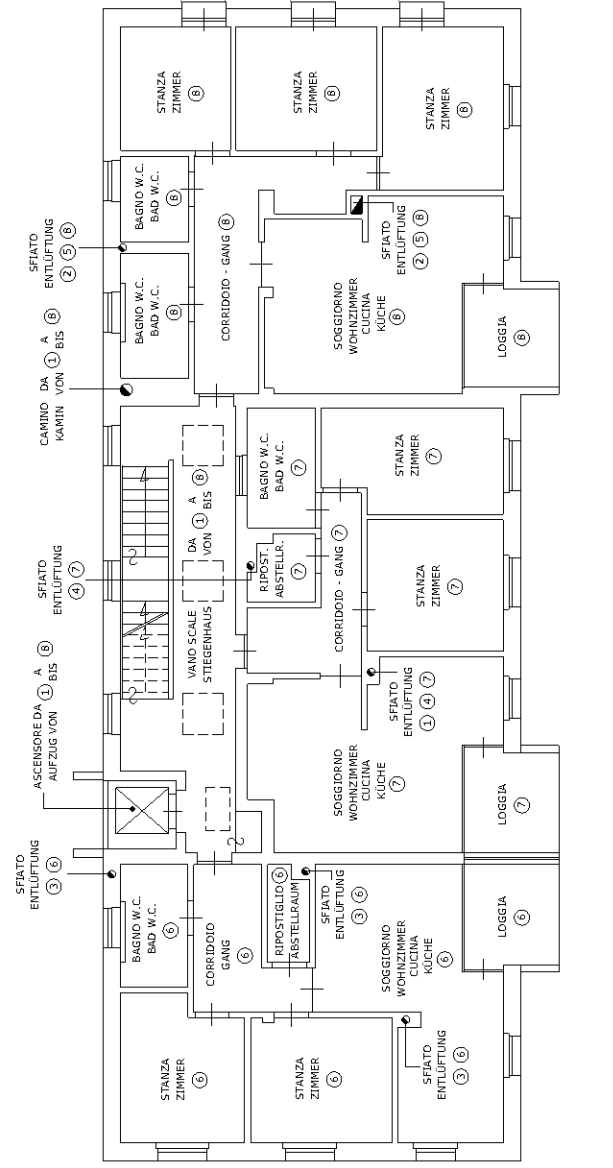

PIANO SOTTOTETTO UNTERDACH

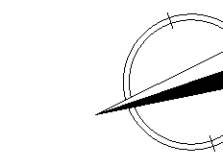
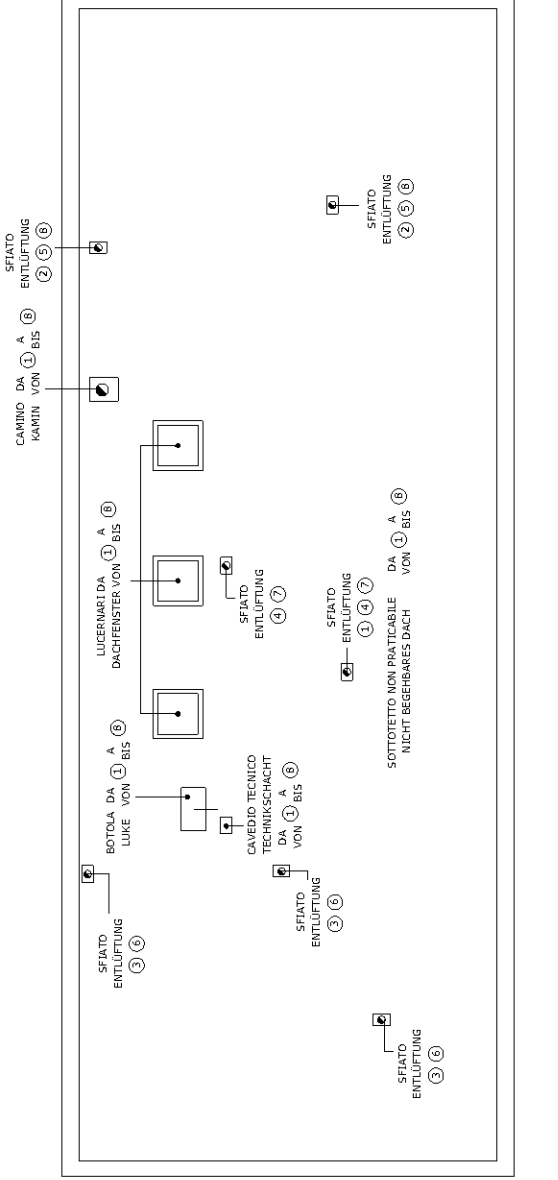

TETTO DACH

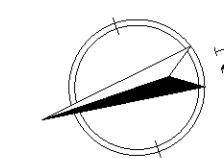
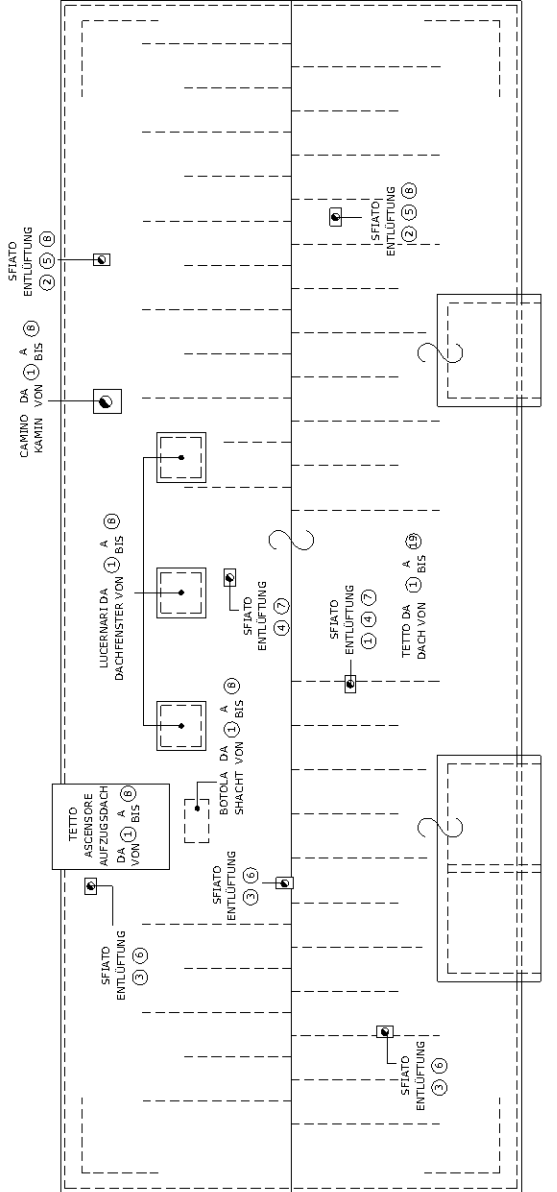

PLANMETRIE CONFORMI
ALLO STATO DI FATTO
ZEICHNUNGEN STIMMEN MIT
DER WIRKLICHKEIT ÜBEREIN